

LF16D

EXTERIOR/INTERIOR LINEAR FLEXIBLE

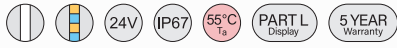

CB



Colour-Matched. Precision-Cut. Quality-Assured. Built to Blend. Install-Ready.

Trusted by designers for precision, consistency, and total system integration. Our updated and extended Linear range brings that same expertise to flexible and rigid luminaires, giving you the freedom to create clean, continuous lines of light, perfectly matched in colour, quality, and performance across every application.

The LF16D combines dual-bend flexibility with extended configuration options including Tunable White and Dim-to-Warm. Designed for projects demanding precision and consistency, it achieves seamless visual integration across the LightGraphix portfolio.

Each unit is made to measure in our UK manufacturing facility and tested to IP67 standards, ensuring long-term reliability in interior, exterior, and marine environments.



KEY FEATURES

- > Colour-matched to the full LightGraphix range for uniform illumination across all luminaire types
- > Dual bend flexibility (top 60mm / side 140mm radius)
- > Colour-matched LEDs within 2-step MacAdam ellipse
- > Flame, Salt, Solvent & UV resistant
- > Continuous lengths up to 5m; 1mm cut accuracy
- > Tunable White, Dim-to-Warm, and Ultra Long configurations (up to 50m)
- > Matching rigid profile: LR17
- > Range of mounting profiles and cable exit options
- > Dimming: 0–10 V, DALI, Casambi, DMX, Mains
- > Cut, finished, and tested in the UK



DIMENSIONS

Dimensions in mm

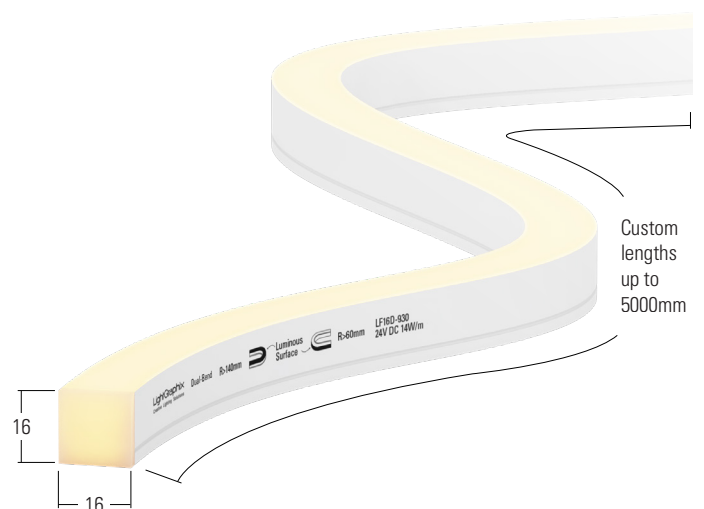
For full dimensions please go to page 3.



WHITE LED ENGINE SPECIFICATION

Engine	 Single White	 TW - Tunable White
Beam angles	120°	120°
Colour temperature*	2200K, 2400K, 2700K, 3000K, 4000K, 5000K	2200-3000K, 2200-6000K
Typical LED Circuit Wattage/m	9W 14W	14W
Delivered lumens (L ₁₀₀)*	498 776	710
Delivered lm/Circuit W**	55 56	51
Source LED lm/m	1,020 1,585	1,447
Source lm/W	113.2 113.2	103.4
Forward voltage (V ₁₀₀)	24V	24V
CRI	90	90
Colour consistency	2 SDCM	2 SDCM
LOR	0.49	0.49
UGR rating ('downlight' mounted)	22.1	22.1
BUG rating ('downlight' mounted)	B0-U0-G0	B0-U0-G0
TM30	RF91 RG98	RF91 RG98
LED lifetime (25° ambient)	L80B50 at 50,000hrs	L80B50 at 50,000hrs
Applications		

These values are based around a LD16D-930 1000mm and LD16D-922-960 1000mm
 *See lumen variance table to the right for lumens apply across all colour temperatures
 **LED wattage includes losses associated with using a 90% efficient driver

Lumen variance by CCT	
2200K	-17%
2400K	-13%
2700K	-5%
3000K	0%
4000K	2%
5000K	7%

MECHANICAL







	9W	14W	14W - TW Tuneable White
Ambient temperature ○ 55°C	-20°C to 55°C	-20°C to 45°C	-20°C to 45°C
	498lm/m	776lm/m	710lm/m
Minimum bend radius	Top	60mm	60mm
	Side	140mm	140mm
Materials	Silicon, Copper		Silicon, Copper
Weight of product (per m)	250g		250g
IP rating	IP67		IP67
IK rating	IK06		IK06
Resistance capabilities	Flame, Salt, Solvent & UV		Flame, Salt, Solvent & UV
Cable	Pre-Wired 2 core silicon cable 1000mm*		Pre-Wired 3 core silicon cable 1000mm*
Wiring	Parallel constant voltage wiring 24V		Parallel constant voltage wiring 24V
Max. installed length	5m		5m
Cut Increments	1mm		1mm
Cut Tolerance	5mm		5mm

*Custom length on request

ENVIRONMENTAL

TM65	Available on request
TM66	1.5

LINEAR FLEX RANGE OVERVIEW

	LF04S-T	LF10D	LF16D	LF20D
				
Size	4mm x 8mm	10mm x 10mm	16mm x 16mm	20mm x 20mm
Applications	<ul style="list-style-type: none"> > Recessed into joinery 	<ul style="list-style-type: none"> > Exterior > Architectural & Facade > Cove & Contour > Wet niche curved applications, which are not suitable for rigid profiles 	<ul style="list-style-type: none"> > Exterior > Architectural & Facade > Cove & Contour > Wet niche curved applications, which are not suitable for rigid profiles 	<ul style="list-style-type: none"> > Exterior > Architectural & Facade > Cove & Contour > Wet niche curved applications, which are not suitable for rigid profiles
IP Rating	IP54	IP67	IP67	IP67
Lumen/m	244	461	777	824
Wattage/m	9W	8W	14W	14W
CRI	90	90	90	90
CCT	2200K, 2400K, 2700K, 3000K, 4000K, 5000K	2200K, 2400K, 2700K, 3000K, 4000K, 5000K	2200K, 2400K, 2700K, 3000K, 4000K, 5000K	2200K, 2400K, 2700K, 3000K, 4000K, 5000K
Dynamic options	N/A	N/A	 Tunable white	 RGBW
Rigid Version	N/A	<p>LR12</p> 	<p>LR17</p> 	<p>LR20</p> 

THE LINEAR RANGE THAT YOU WOULD EXPECT FROM LIGHTGRAPHIX

Trusted by designers for precision, consistency, and total system integration. Our updated and extended Linear range brings that same expertise to flexible and rigid luminaires, giving you the freedom to create clean, continuous lines of light, perfectly matched in colour, quality, and performance across every application.

Colour-Matched

Developed using LightGraphix-engineered LED tape, tightly binned within a two-step MacAdam ellipse. Every luminaire is visually and chromatically matched across our full range from downlights and uplights to spotlights and linear delivering consistent light quality and tone throughout the project.

Precision-Cut

Every fitting is made to measure in our UK operations - cut, connected, moulded, and IP-tested in-house. With 1mm cutting accuracy and continuous lengths up to 5m, each product delivers technical precision and a flawless finish, ensuring your specification is realised exactly as intended.

Quality-Assured

Engineered for demanding environments, every LightGraphix Linear fitting undergoes 100% testing. Constructed from high-grade materials, including marine-quality silicon, the range is IP67-rated and resistant to flame, UV, saltwater, and solvents. Built for longevity, reliability, and performance - indoors, outdoors, or at sea.

Built to Blend

Designed to give you ultimate flexibility for your lighting design, each Linear product integrates seamlessly with our wider portfolio. Flexible and Rigid options share the same light engines, allowing continuous lines of light that sit discreetly within the architecture and maintain design integrity.

Install-Ready

Engineered, assembled, and tested through our UK operations for dependable performance and rapid turnaround. Custom lengths, pre-moulded connections, and a 5-year warranty reduce on-site work, minimise risk, and ensure every luminaire arrives ready to install.

COLOUR MATCHING

At LightGraphix, colour matching goes beyond specifying the same CCT.

LEDs naturally exhibit chromatic shift as they warm, which can affect the final appearance and create perceptible inconsistencies across a lighting scheme. Our LEDs are tightly binned at 25°C within a two-step MacAdam ellipse and carefully selected to maintain colour consistency and light quality once stabilised in use. This ensures seamless integration between linear products and other LightGraphix luminaires within the project, delivering confidence wherever LightGraphix is specified.

C1 and E3 travel through the flex colour point

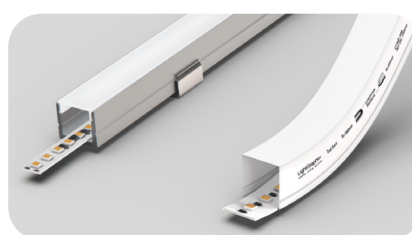
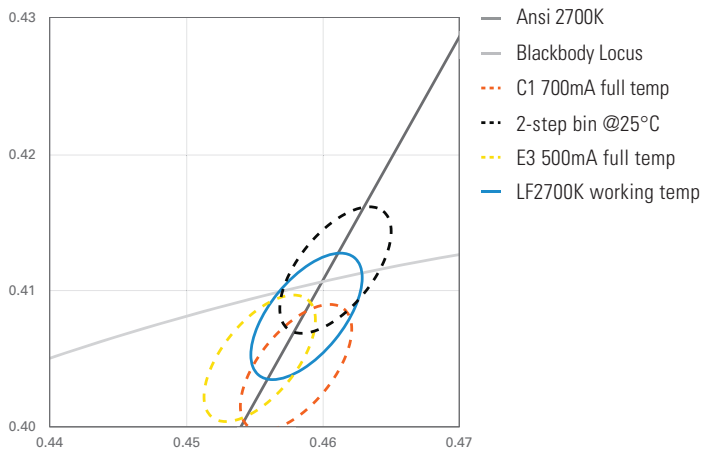

DIMENSIONS AND FIXING ACCESSORIES

Dimensions in mm

LF16

16 x 16mm square profile, available in specifiable lengths at 1mm increments from 300mm to 5000mm. Low profile moulded cable entry & ends.

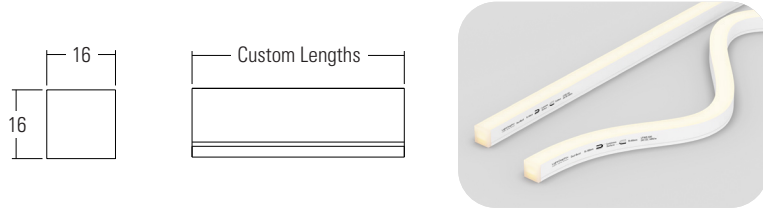

FIXINGS

Dimensions in mm

PROFILES

Dimensions in mm

/SCLF16 Spring Clip

Stainless steel finish. Surface mount sprung stainless steel spring clips, fixed by one screw to the mounting surface. For recessed installation applications an 18mm wide slot is recommended to installing the clips in to. Fixings every 200mm are recommended for typical installation. **(Supplied in bags of 20)**

/CCLF16 Clear Clip

Transparent clear finish. The Clear Clip provides secure retention over the top of the LF product but still allows light to be seen. Fixings every 200mm are recommended for typical installation. **(Supplied in bags of 20)**

/BCLF16 Bendable Channel

Stainless steel finish. The Bendable Channel allows precise control over the position of the LF product in 3 dimensions. For recessed applications, allow an 18.1mm slot for inserting the Bendable Channel into. **(Supplied in 1m lengths)**

/ELF16 Channel

Plain aluminium finish. The Extruded Channel allows surface mounted or recessed installation in straight lines. For recessed applications, allow a 18.3mm slot for inserting the Extruded channel into. **(Supplied in 1m lengths)**

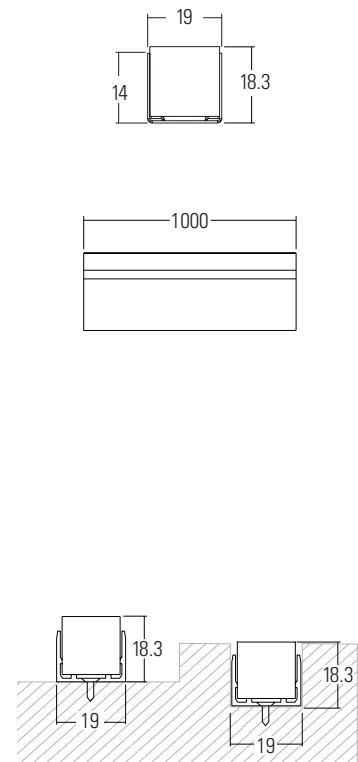
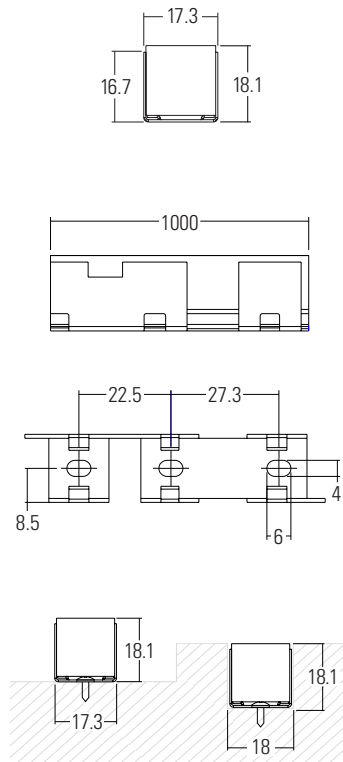
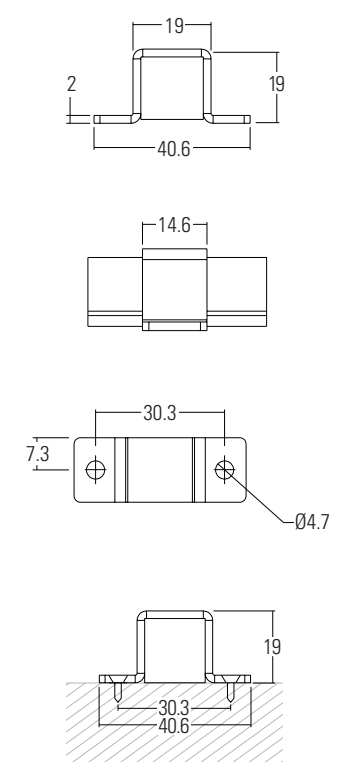
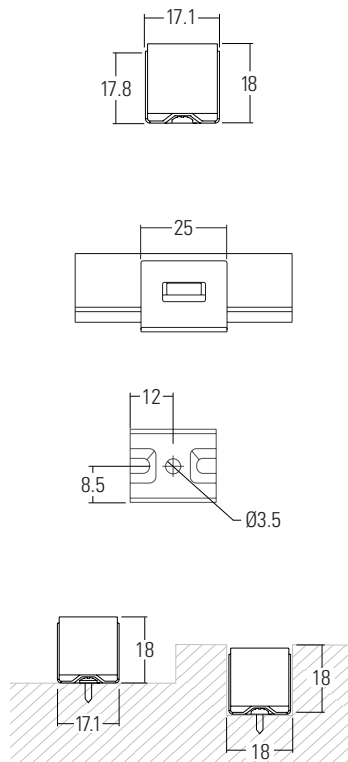
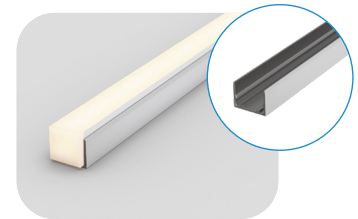
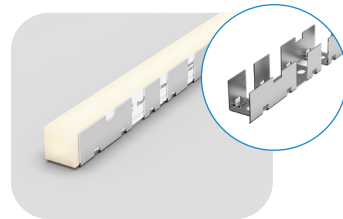
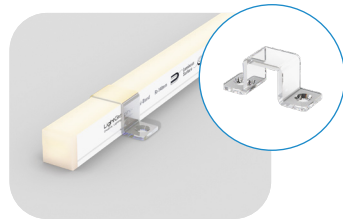
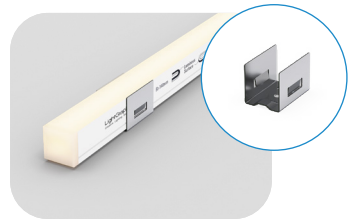

MINIMUM BEND RADIUS

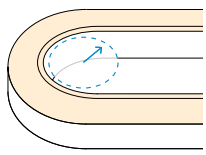

Side Bend Radius
140mm

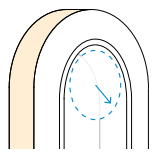

Top Bend Radius
60mm

END, REAR, LEFT & RIGHT CABLE EXIT

Dimensions in mm

/End Exit

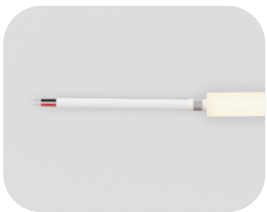

/Rear Exit

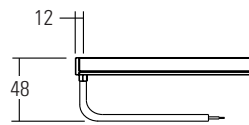
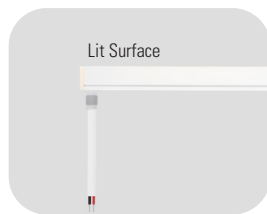

/Left Exit

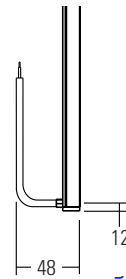
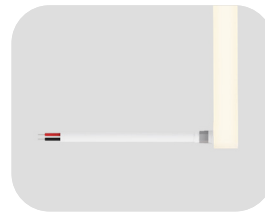

/Right Exit

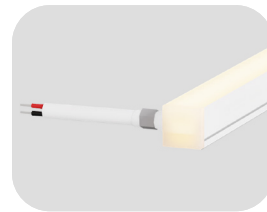
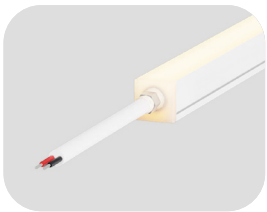
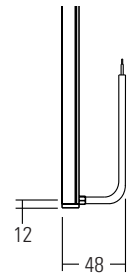
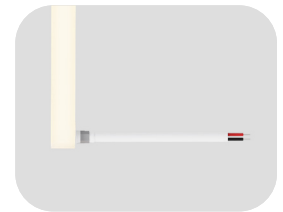

CREATING CONTINUOUS LINES

Mounting the products end to end with opal translucent endcaps will create a continuous line of light. To enable this configuration, please select either the rear, left or right exit.



ORDER CODES & OPTIONS

Example: LF16D-14W/927/End Exit/5000mm

Light Engine & Drive Current

LED Colour

Cable Exit

Length (5000mm Max)

Fixing & Profiles

/ / / /

Ambient temperature key: ● 55°C

White

24V 9W/m	LF16D-9W
24V 14W/m	LF16D-14W

Super Warm White (2200K)	/922
Very Warm White (2400K)	/924
Extra Warm White (2700K)	/927
Warm White (3000K)	/930
White (4000K)	/940
Cool White (5000K)	/950

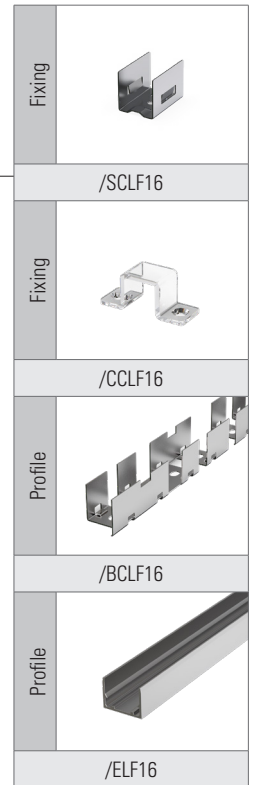
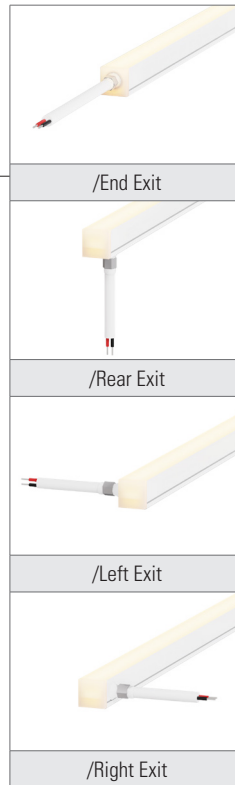

TW

24V 14W/m	LF16D-14W
-----------	-----------

Tunable White 2200K -3000K	/TW-922-930
Tunable White 2200K -6000K	/TW-922-960

Drivers

To be used with 24V constant voltage LED Drivers and Controllers, We offer a range of drivers with 1-10V, DMX, and DALI dimming options. Please download the data sheet from the downloads section at www.lightgraphix.co.uk, or contact us for more information.